



Safety & Instruction Manual



R22™

Semi-auto 22LR rifle



**Read the instructions and
warnings in this manual
CAREFULLY BEFORE
using this firearm.**

THOMPSON/CENTER ARMS
2100 Roosevelt Avenue
Springfield, MA 01104
Phone: 866-730-1614
www.tcarms.com



WARNING:



**READ THESE INSTRUCTIONS
AND WARNINGS CAREFULLY.
BE SURE YOU UNDERSTAND THESE
INSTRUCTIONS AND WARNINGS
BEFORE USING THIS FIREARM.
FAILURE TO READ THESE INSTRUCTIONS
AND TO FOLLOW THESE WARNINGS
MAY RESULT IN SERIOUS INJURY
OR DEATH TO YOU AND OTHERS AND
DAMAGE TO PROPERTY.**

**This SAFETY & INSTRUCTION
MANUAL should always accompany
this firearm and be transferred with it
upon change of ownership or when
presented to another person.
A copy of the SAFETY & INSTRUCTION
MANUAL is available FREE
via download at
www.tcarms.com
OR UPON REQUEST FROM:**

**Thompson/Center
CUSTOMER SUPPORT CENTER
2100 ROOSEVELT AVENUE
SPRINGFIELD, MA 01104
Phone: 866-730-1614
E-mail: qa@tcarms.com**

TABLE OF CONTENTS

YOUR SAFETY RESPONSIBILITIES	3-6
SAFE STORAGE AND TRANSPORTATION.....	7-8
AMMUNITION	9-10
MODEL AND FEATURES IDENTIFICATION	11
INSPECTING YOUR RIFLE	12-13
PREPARATION FOR FIRING.....	14
LOADING.....	15-17
FIRING.....	17-18
CLEARING MISFIRES / MISFEEDS	18-19
UNLOADING	20-21
DISASSEMBLY / FIELD STRIPPING	21-23
LUBRICATION.....	24
ASSEMBLY / FIELD STRIPPING	24-26
REAR SIGHT ADJUSTMENT	27
MAGAZINE	28-32
SCOPE MOUNTING	33
CLEANING AND MAINTENANCE	34-36
LIMITED LIFETIME WARRANTY	37-38
CONTACT AND SHIPPING FOR SERVICE	39-40
M-LOK® ACCESSORY RAIL SLOTS	41
BATTERY WARNINGS	42
PATENT INFORMATION.....	43

YOUR SAFETY RESPONSIBILITIES

SAFETY IS YOUR NUMBER ONE RESPONSIBILITY!!!!

- At home, in the field, at the range, or anywhere, the first concern of every firearm owner should be safety. Apply the following safety rules in every situation, with any kind of firearm. If you feel uncertain about any operational aspects of your firearm, please contact Thompson/Center at 866-730-1614, before proceeding with its operation.
- If you are unfamiliar with firearms you should seek formal training before using your rifle.



WARNING: YOU MUST FOLLOW ALL OF THESE SAFETY RULES TO ENSURE THE SAFE USE OF YOUR FIREARM. THE FAILURE TO FOLLOW THE INSTRUCTIONS AND WARNINGS IN THIS MANUAL COULD CAUSE SERIOUS PERSONAL INJURY OR DEATH TO YOU OR OTHERS AND DAMAGE TO PROPERTY.

- As a firearm owner, you accept a demanding responsibility. How seriously you take this responsibility can be the difference between life and death. There is no excuse for careless or abusive handling of your firearm. At all times handle your firearm with intense respect for its power and potential danger.

YOUR SAFETY RESPONSIBILITIES CONTINUED

- **ALWAYS KEEP YOUR FIREARM POINTED IN A SAFE DIRECTION.** Never point a firearm at anyone or anything you do not intend to shoot whether or not it is loaded. This is particularly important when loading, unloading, or field stripping the firearm. ALWAYS control the direction of the firearm.
- **ALWAYS TREAT EVERY FIREARM AS IF IT IS LOADED AND WILL FIRE.** Do not take anyone's word that the firearm is unloaded – always check for yourself. Never pass your firearm to another person until the cylinder or action is open and you visually check that it is unloaded. Keep your firearm unloaded and safely stored when not in use.
- **NEVER PLACE YOUR FINGER INSIDE THE TRIGGER GUARD OR ON THE TRIGGER UNLESS YOU INTEND TO FIRE.** Ensure that other objects do not touch the trigger.
- **ALWAYS BE SURE OF YOUR TARGET AND WHAT IS BEYOND IT.** Always be sure of where the bullet will strike and shoot only where there is a safe back stop free of obstructions, water or other surfaces which can cause ricochets. Be sure your bullet will stop behind your target. Bullets can glance off many surfaces like rocks or the surface of water and travel in unpredictable directions with considerable velocity. Do not fire randomly into the sky.
- **NEVER CROSS OBSTACLES SUCH AS FENCES OR STREAMS WITH A LOADED FIREARM.** Always make certain your firearm is unloaded before crossing a fence, climbing a tree, jumping a ditch or negotiating other obstacles.
- **SAFE FIREARM HANDLING IS YOUR PERSONAL RESPONSIBILITY AT ALL TIMES.** Firearms are dangerous and can cause serious injury or death if they are misused or used inappropriately. Safety must be the prime consideration of anyone who owns or handles firearms. Accidents are the result of violating the rules of safe firearm handling and common sense. Firearm safety training is available. Contact your firearms dealer, law enforcement agency, local sportsman's club, etc. for availability.
- **YOU ARE RESPONSIBLE FOR THE FIREARM AT ALL TIMES.** In owning a firearm, you must undertake full-time responsibility for your firearm's safety and security. You must protect yourself and all others against injury or death from misuse of the firearm 24 hours a day.
- **FIREARM SECURITY IS YOUR RESPONSIBILITY.** You must secure firearms safely from children and/or unauthorized users. Your firearm should always be kept unloaded and locked when not in use. A lock has been provided for this purpose. Never assume that the use of this lock is sufficient to safely secure your firearm. You must always evaluate your personal situation and employ the security systems that meet your needs and prevent children and unauthorized users from gaining access to your firearm.

YOUR SAFETY RESPONSIBILITIES CONTINUED

- **APPROPRIATE USE FOR YOUR FIREARM MEANS USING YOUR FIREARM FOR LEGAL PURPOSES.** For example - target shooting, hunting and lawful resistance of deadly criminal force. It is your responsibility to ensure that you are in compliance with all applicable laws and ordinances regarding the use of your firearm.
- **NEVER RELY ON MECHANICAL FEATURES ALONE.** Only your safe firearm handling habits will ensure the safe use of your firearm. This is your responsibility.
- **ALWAYS SAFELY STORE AND SECURE YOUR FIREARM.** Safe and secure storage of your firearm is one of your most important responsibilities. It is a full-time responsibility. You must always secure your firearm and ammunition separately so that they are not accessible to children and/or other unauthorized persons.
- **NEVER KEEP AMMUNITION IN THE SAME LOCATION AS THE FIREARM.** Store each in a separate and secure place.
- **ALWAYS WEAR EYE PROTECTION THAT IS SPECIFIED FOR USE WITH FIREARMS** every time you handle your firearm for cleaning and maintenance.
- **ALWAYS WEAR EYE AND HEARING PROTECTION THAT ARE SPECIFIED FOR USE WITH FIREARMS** every time you discharge your firearm. Make sure others in the vicinity of where you will be shooting do so as well.
- **NEVER USE ALCOHOL OR DRUGS BEFORE OR WHILE SHOOTING.** Do not use your firearm if you are on any medication which impairs, even slightly, your mental or physical ability.
- **ALWAYS HAVE ADEQUATE VENTILATION.** Discharging firearms in poorly ventilated areas, cleaning firearms, or handling ammunition may result in exposure to lead and other substances known to cause birth defects, reproductive harm, and other serious physical injury. Review the warnings and labels for all ammunition and cleaning products carefully. Wash hands thoroughly after exposure.
- **BEFORE HANDLING ANY FIREARM, UNDERSTAND ITS OPERATION.** Not all firearms are the same. Familiarize yourself with the mechanical features of any firearm you intend to use. If you feel uncertain about any operational aspects of your firearm, please contact Thompson/Center at 866-730-1614, before proceeding with its operation.
- **NEVER ALLOW A FIREARM TO BE USED BY INDIVIDUALS WHO DO NOT UNDERSTAND ITS SAFE OPERATION OR HAVE NOT READ THESE FIREARM SAFETY RULES.**

YOUR SAFETY RESPONSIBILITIES CONTINUED

- **ALWAYS USE THE CORRECT AMMUNITION FOR YOUR PARTICULAR FIREARM** as indicated by the marking on the firearm. Never use non-standard, reloaded, or “handloaded” ammunition which has not been subjected to internal ballistic pressure testing.
- **BEWARE OF BARREL BORE OBSTRUCTIONS** Be sure the bore is clear of obstructions before shooting. Mud, water, snow or other objects may inadvertently lodge in the barrel bore. A small obstruction can cause a dangerous increase in pressure and may damage your firearm and cause injury to yourself and others.
- **BE SURE ALL ACCESSORIES, SUCH AS HOLSTERS, GRIPS, SLINGS, SCOPES AND OTHER ACCESSORIES ARE COMPATIBLE** with the firearm and that the accessories do not interfere with safe operation. It is your responsibility to understand and follow all of the instructions in this manual, as well as those which may be supplied with your ammunition and any accessory.
- **NEVER DISASSEMBLE YOUR FIREARM** beyond the field stripping procedure outlined in this manual. Improper disassembly or reassembly of your firearm may be dangerous and can lead to serious injury or death.
- **NEVER MANIPULATE, ADJUST OR CHANGE ANY OF THE INTERNAL COMPONENTS OF YOUR FIREARM UNLESS SPECIFICALLY INSTRUCTED TO DO SO IN THIS MANUAL.** Improper manipulation of any component may affect the safety and reliability of your firearm and may cause serious injury or death.
- **NEVER ALLOW ANY ALTERATION OR REPLACEMENT OF PARTS IN YOUR THOMPSON/CENTER FIREARM UNLESS PERFORMED BY A QUALIFIED GUNSMITH** using genuine Thompson/Center parts. If you do otherwise, improper functioning of your firearm may occur and serious injury or death and damage to property may result.



WARNING: SAFE USE OF A FIREARM IS YOUR PERSONAL RESPONSIBILITY AND THE FAILURE TO FOLLOW ALL OF THESE BASIC SAFETY RULES MAY RESULT IN SEVERE PERSONAL INJURY OR DEATH TO YOU OR OTHERS AND DAMAGE TO PROPERTY. YOU ARE THE MOST IMPORTANT SAFETY DEVICE WHEN IT COMES TO THE USE OF YOUR FIREARM AND THOMPSON/CENTER WILL NOT BE RESPONSIBLE FOR ANY PERSONAL INJURY, DEATH OR PROPERTY DAMAGE THAT RESULTS FROM: (1) THE CRIMINAL OR NEGLIGENT USE OF THIS FIREARM; (2) A DISREGARD OF THESE SAFETY INSTRUCTIONS AND WARNINGS; (3) IMPROPER OR CARELESS HANDLING OF THIS FIREARM; (4) THE USE OF NON-STANDARD, DEFECTIVE, IMPROPER OR RELOADED AMMUNITION; OR (5) IMPROPER OR NEGLIGENT MODIFICATIONS OR REPAIRS TO THE FIREARM.

SAFE STORAGE AND TRANSPORTATION



WARNING: ALWAYS POINT THE MUZZLE IN A SAFE DIRECTION.



WARNING: FIREARMS ARE DANGEROUS WHEN USED AND STORED IMPROPERLY. THEY POSE A RISK OF SERIOUS OR FATAL INJURIES. FIREARMS CAN BE ESPECIALLY DANGEROUS TO CHILDREN WHEN THEY ARE STORED IN AN IRRESPONSIBLE AND UNSAFE MANNER. FOR YOUR SAFETY AND THE SAFETY OF OTHERS, IT IS IMPERATIVE THAT YOU KEEP YOUR FIREARM LOCKED AND UNLOADED IN A SECURE PLACE. THE AMMUNITION SHOULD BE STORED IN A SEPARATE, SECURE LOCATION WHEN IT IS NOT IN USE. SAFE AND SECURE STORAGE OF YOUR FIREARM IS ONE OF THE MOST IMPORTANT RULES OF FIREARM SAFETY. YOUR FAILURE TO FOLLOW THESE RULES MAY RESULT IN SERIOUS INJURY OR DEATH TO YOU OR OTHERS.

- **ALWAYS SECURE YOUR FIREARM IN A MANNER THAT WILL PREVENT UNAUTHORIZED ACCESS.** Whenever your firearm is not in use, keep it unloaded and locked. Your safety and the safety of others requires that you always secure and store your firearm in a manner that will prevent unauthorized access. Never leave a firearm unattended unless it is locked, unloaded and secured.
- **ALWAYS USE THE LOCK PROVIDED BY THOMPSON/CENTER TO SECURE YOUR FIREARM.** Please read and follow the instructions packaged separately for the use of this lock. A lock, when properly used, can be an effective tool in preventing unauthorized access to your firearm. There are other alternative locks and safe storage containers available in the marketplace which may also be appropriate for your particular needs. Consult your local gun shop, hardware store, or local police department for guidance on the variety of other safe storage devices or practices which may be appropriate for your particular needs. By purchasing this firearm you have accepted the responsibility of safely securing the firearm at all times and preventing its unauthorized use. Never assume that the use of this lock alone is sufficient to safely secure your firearm. It is your personal responsibility to select and use whatever measures or practices that will enable you to be absolutely certain that your firearm is secure at all times.



WARNING: NEVER LOCK A LOADED FIREARM AND NEVER LOAD A LOCKED FIREARM!

SAFE STORAGE AND TRANSPORTATION CONTINUED

- **ALWAYS STORE YOUR FIREARM AND AMMUNITION SEPARATELY** so that they are not accessible to children or other unauthorized persons. Safe and secure storage of your firearm and ammunition are your responsibility. It is a full-time responsibility.
- **NEVER ASSUME THAT A “HIDING” PLACE IS A SECURE STORAGE METHOD.** Others may be aware of your storage location or come upon it by chance. It is your personal responsibility to use common sense when storing your firearm and ammunition and to always make sure they are not accessible to children or other unauthorized persons.
- **NEVER TRANSPORT A LOADED FIREARM.** When transporting your firearm, be sure it is unloaded and locked. Safe and secure transportation of your firearm is your responsibility.
- **ALWAYS FOLLOW THE LAW!** Many jurisdictions have laws that make it a crime to keep a firearm unlocked and in an area accessible to children or others. Keeping a firearm locked and unloaded when not in use is not only common sense safety practice... IT IS THE LAW. You must be familiar with all local, state, and federal laws regarding the safe storage and transportation of your firearm. Failure to know and follow the law may result in unauthorized access or use of your firearm by another. Obey all laws relating to the storage and transportation of firearms. Your local police department or gun shop can furnish you with available information on storing and/or transporting a firearm safely and legally.
- **YOUR FIREARM IS YOUR RESPONSIBILITY.** You must prevent your firearm from being stolen or from being used by untrained or unqualified individuals. Keep it locked, unloaded and secured when not in use.
- Never leave the key with the stored firearm.

AMMUNITION



WARNING: NEVER USE AMMUNITION NOT SPECIFICALLY DESIGNATED FOR USE IN YOUR FIREARM. FAILURE TO USE THE CORRECT TYPE OR CALIBER OF AMMUNITION MAY CAUSE THE FIREARM TO JAM, OR FAIL TO FIRE, OR MAY GENERATE EXCESSIVE PRESSURE WHICH CAN DAMAGE OR EVEN RUPTURE YOUR FIREARM, CAUSING PERSONAL INJURY OR DEATH TO THE SHOOTER OR BYSTANDERS.

- Locate the cartridge designation marked on the firearm. This information indicates the correct ammunition that must be used in this firearm (FIGURE 1).
- You are responsible for selecting ammunition that meets industry standards and is appropriate in type and caliber for this firearm.

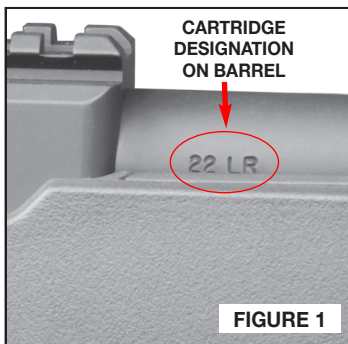

WARNING: NEVER USE AMMUNITION OF THE INCORRECT GAUGE OR CALIBER. USING AMMUNITION OF THE INCORRECT GAUGE OR CALIBER MAY CAUSE DAMAGE TO YOUR FIREARM AND POSSIBLE SERIOUS INJURY TO YOU AND TO OTHERS.

- Never mix ammunition.



WARNING: IN SOME CASES, A ROUND OF AMMUNITION NOT SPECIFIED ON YOUR FIREARM MAY FIT INTO THE CHAMBER. FIRING THIS AMMUNITION MAY CAUSE A RUPTURE AND/OR BORE OBSTRUCTION RESULTING IN PERSONAL INJURY OR DEATH TO THE SHOOTER OR BYSTANDERS AND DAMAGE TO PROPERTY.



WARNING: ALWAYS INSPECT YOUR AMMUNITION BEFORE USING IT. NEVER USE DIRTY, CORRODED OR DAMAGED AMMUNITION. A BURST CARTRIDGE MAY RESULT IN PERSONAL INJURY OR DEATH TO THE SHOOTER OR BYSTANDERS AND DAMAGE TO PROPERTY.

- Use only commercially manufactured ammunition with internal ballistic pressures which are in strict accordance with the specifications of the Sporting Arms and Ammunition Manufacturers' Institute (SAAMI). If you are uncertain, contact your ammunition supplier for verification.

AMMUNITION CONTINUED

- Critical to performance and maintenance of a rifle is regular cleaning and the use of high-quality ammunition. This is even more important with 22 caliber rifles. There is a broad array of 22LR ammunition made by a number of manufacturers in different brands and types. Thompson/Center has found wide variations in primer sensitivity and other characteristics between some brands and types of 22LR ammunition.
- Thompson/Center suggests that you fire several boxes of a quality brand of ammunition through your T/CR22™ before you put it into regular use to determine reliability of ignition and performance of your ammunition. If “failure to fire” or other issues should occur, try different brands and types until a reliable load is found.
- Please call Thompson/Center Customer Service at 866-730-1614 if you have any questions regarding ammunition and maintenance of your T/CR22™ rifle.
- A firearm and ammunition are a system and must work together. There are different types of ammunition for different types of firearms. Your firearm has been designed for ammunition of a specific type and a specific gauge or caliber. It is important to select the proper ammunition for your firearm.



WARNING: DEATH, SERIOUS INJURY AND DAMAGE CAN RESULT FROM THE USE OF INCORRECT AMMUNITION OR BORE OBSTRUCTIONS.

MODEL AND FEATURES IDENTIFICATION

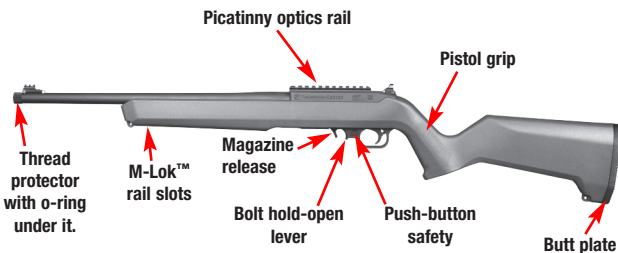
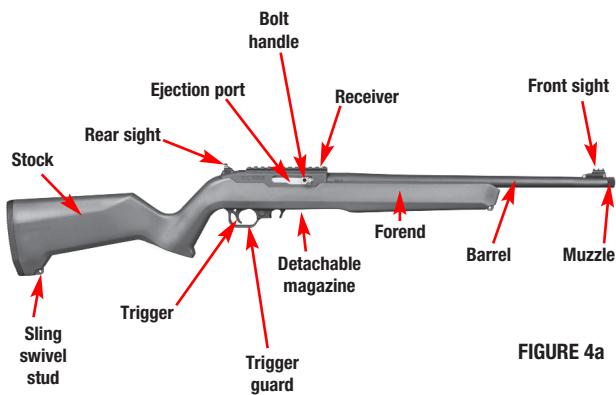
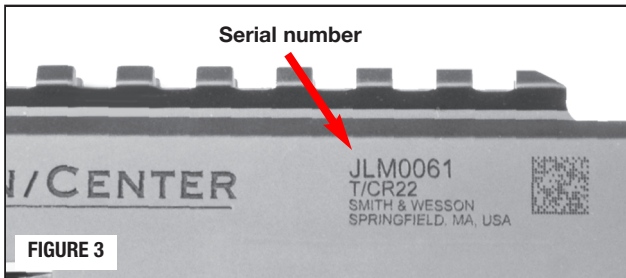
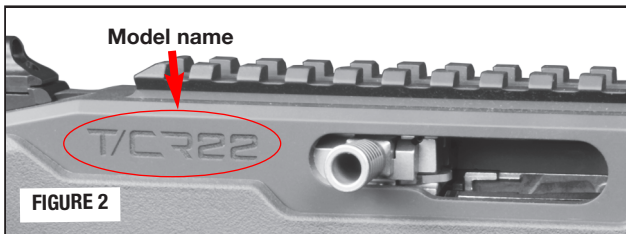

Muzzle is threaded 1/2-28 for muzzle devices - sold separately

FIGURE 4b

INSPECTING YOUR RIFLE



WARNING: ALWAYS ENSURE THAT THE FIREARM IS UNLOADED BEFORE INSPECTING, DISASSEMBLING OR ASSEMBLING AND ALWAYS KEEP THE MUZZLE POINTED IN A SAFE DIRECTION.



WARNING: NEVER RELY ON MECHANICAL FEATURES ALONE. ONLY YOUR SAFE FIREARM HANDLING WILL ENSURE THE SAFE USE OF YOUR FIREARM. THIS IS YOUR RESPONSIBILITY.

- When shipped from the factory, your rifle had an empty chamber flag (FIGURE 5a) to indicate that no cartridge is present in the chamber (FIGURE 5b). In the process of inspecting your rifle, you should remove this flag once the magazine is removed from the rifle and the bolt is locked open - using the following procedure.

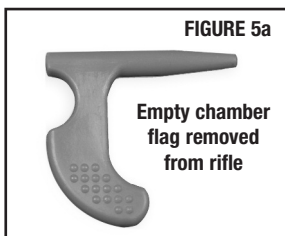

- First, check for yourself to ensure that the rifle is unloaded. To do this, grasp the rifle with your finger off the trigger and outside the trigger guard. Point the muzzle in a safe direction and press the magazine release forward and remove the magazine down and out of the rifle (FIGURE 6). Set the magazine aside.

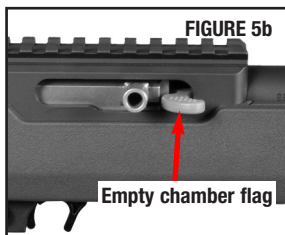

- Locate the bolt hold-open lever (FIGURE 7).
- Pull the bolt handle all the way back, press and hold the bolt hold-open lever up and back while you slowly let the bolt move forward slightly. This will lock the bolt in the open position (FIGURE 8).
- If present, remove the chamber flag from the rifle and set it aside.

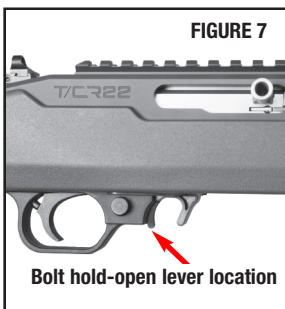
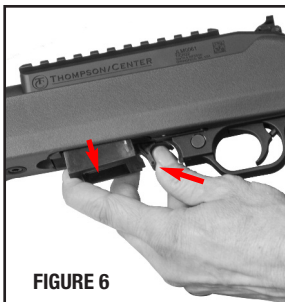

INSPECTING YOUR RIFLE CONTINUED

- Push the sliding safety button into the SAFE position (where no red line is visible on the safety button) (see FIGURES 9 and 10).

NOTE: If the safety button does not easily go into the SAFE position, DO NOT attempt to force it into SAFE. While keeping the muzzle pointed in a safe direction, remove the magazine and lock your bolt open as instructed here and then place the safety button into the SAFE position before proceeding.

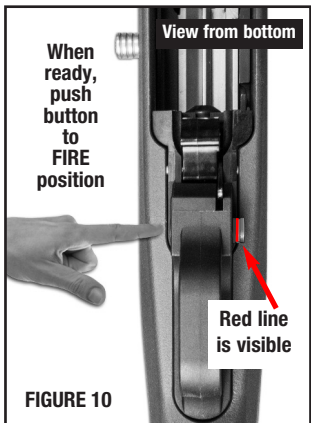
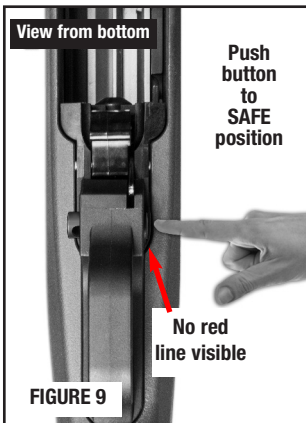
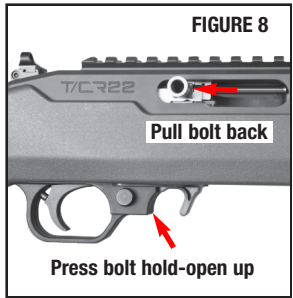

- Look into the ejection port and check the chamber to be sure no cartridges are present (FIGURE 11).
- You must follow this procedure every time a firearm leaves your hands, is cleaned, is handed to you or to another person, is transported or when it is stored.
- Unload the magazine by holding it with the bullet end of the cartridge pointing away from you and pushing each cartridge forward and out of the magazine (FIGURE 12).
- Before using your firearm for the first time, it should be cleaned. See the cleaning section of this manual.

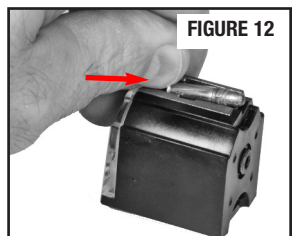

CAUTION: Never dry-fire the rifle as damage to the firearm could result.

PREPARATION FOR FIRING



WARNING: THE FAILURE TO FOLLOW THESE FIREARM SAFETY REQUIREMENTS WILL CAUSE SERIOUS PERSONAL INJURY OR DEATH TO YOU OR OTHERS.

- **ALWAYS TREAT ALL FIREARMS AS IF THEY ARE LOADED.**
- **ALWAYS BE SURE THAT ALL ACTIONS OF FIREARMS ARE OPEN, THAT CHAMBERS ARE CLEAR OF CARTRIDGES AND MAGAZINES ARE REMOVED OR UNLOADED, AND THAT FIREARM IS POINTING IN A SAFE DIRECTION.**
- **ALWAYS KEEP FINGERS AND OTHER PARTS OF YOUR BODY AWAY FROM THE MUZZLE AND AWAY FROM THE EJECTION PORT.**
- **ALWAYS WEAR ADEQUATE AND PROPER HEARING PROTECTION SPECIFIED FOR FIREARM USE** to prevent permanent damage to your hearing. Make sure others who are nearby are wearing hearing protection as well.
- **ALWAYS WEAR SAFETY GLASSES SPECIFIED FOR FIREARM USE**, whether indoors or out. Safety glasses should protect your eyes from the firing flash and particles associated with the discharge of ammunition. Failure to do so creates a risk of personal injury from particle or debris spitting or from a ricochet.
- **ALWAYS BE ALERT AND ALWAYS FOLLOW THE SAFETY INSTRUCTIONS OF THE RANGE OFFICER.** Never shoot if you are tired, cold or impaired in any way.
- **ALWAYS BE AWARE OF OTHER PEOPLE** so that persons do not accidentally walk into the line of fire.
- **THE SHOOTER (AND ALL OTHERS IN THE SHOOTING AREA) MUST ALWAYS BE IN A POSITION THAT IS OUT OF THE LINE OF FIRE** and are not within an area where they may be struck by a ricochet or particles spitting from a firearm, or by ejected cases from some types of firearms.
- **NEVER SHOOT AT SURFACES THAT MAY CAUSE A RICOCHET.** Always select a place to shoot that has a safe backstop, is free from obstructions and has no surfaces which may cause a ricochet.
- **NEVER FIRE RANDOMLY INTO THE SKY.** Always select a place to shoot that has a safe backstop.
- **NEVER USE ALCOHOL OR DRUGS BEFORE OR WHILE SHOOTING OR HANDLING ANY FIREARM.**

LOADING



WARNING: ALWAYS POINT THE MUZZLE IN A SAFE DIRECTION.

- Do not load the rifle until you have read and fully understand this manual.
- Do not load the rifle until you are ready to use it. Keep your finger off the trigger and outside the trigger guard until you are ready to fire.
- Never load your rifle until you are sure of your target, what is beyond it and are fully prepared to fire.
- Thompson/Center™ has provided you with a magazine designed to operate in your specific model of firearm. While your magazine may be able to be inserted into another model firearm, it will only function properly in the specific model for which it was designed. Do not interchange magazines from one model firearm to another model.
- Press the magazine release forward and remove the magazine from the rifle (FIGURE 13).
- Locate the first round load assist lever on the magazine (FIGURE 14).
- Hold the first round load assist lever down as far as it can go and feed the first cartridge down and back - under the feed lips of the magazine (FIGURE 15).
- Push the cartridge down and back fully to the rear of the magazine toward the clear back panel (FIGURES 16a and 16b on the following page).
- Feed each additional round into the magazine by pushing the round in the magazine down with the next round and sliding the next round down and back under the magazine feed lips, seating the round against the rear of the magazine.
- The standard magazine capacity for the T/CR22™ is ten rounds of 22 long rifle ammunition. Do not attempt to load your magazine beyond its standard capacity.

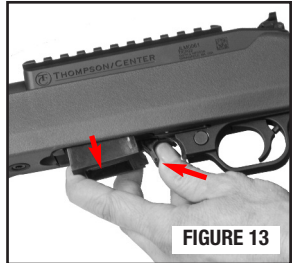

FIGURE 13

First round load assist lever

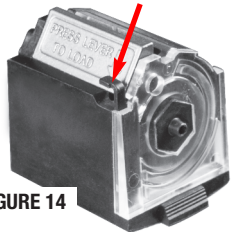

FIGURE 14

While pressing first round load assist lever

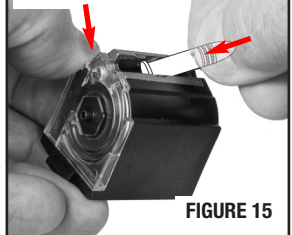

FIGURE 15

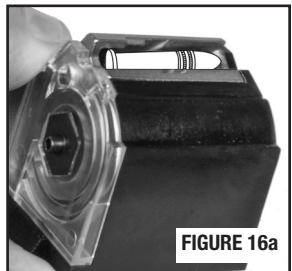

FIGURE 16a

LOADING CONTINUED

- Insert the cartridges fully to the rear of the magazine toward the clear back panel (FIGURES 16a on the previous page and 16b).
- Pull the bolt handle all the way back and press the bottom of the bolt hold-open lever up and back and then let the bolt move forward slightly. This will lock the bolt in the open position (FIGURE 17).
- Set safety button to the SAFE position (FIGURE 18).
- With the cartridges oriented as shown (FIGURE 19), insert the loaded magazine into rifle fully until it is locked into place.



WARNING: ALWAYS POINT THE MUZZLE IN A SAFE DIRECTION.

- Keeping your fingers away from the ejection port and keeping the muzzle pointed in a safe direction, pull the bolt handle fully to the rear to disengage the bolt hold-open and then release the bolt handle, allowing it to move forward briskly - feeding a round from the magazine into the chamber of the rifle (FIGURE 20). The rifle is now loaded and will fire if the safety button is moved to the FIRE position and the trigger is pulled.
- If you wish to restore the magazine in your rifle to its full capacity after loading a round into the chamber, depress the magazine release and remove the magazine from the rifle. Remember that there is a round in the chamber; therefore, the rifle should be handled safely during this process without touching the trigger. Load one cartridge into the magazine to replace the one which was chambered when you allowed the bolt to close forward. Re-insert the fully loaded magazine into the rifle until it is locked in place.

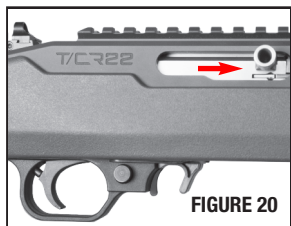
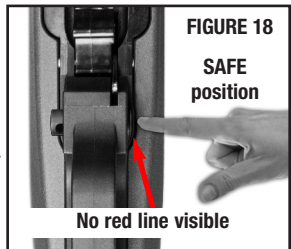
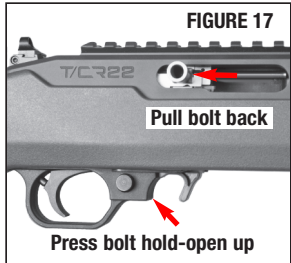
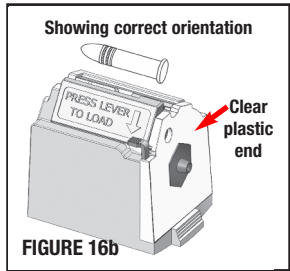

LOADING CONTINUED

- If the bolt does not completely close and chamber a round, the bolt must be opened and the round cleared from the rifle. See the section of this manual regarding Clearing Misfeed/Misfires.

 **WARNING: NEVER STRIKE OR DROP THE FIREARM. DOING SO MAY CAUSE A ROUND TO CHAMBER WHEN A LOADED MAGAZINE IS PRESENT IN THE RIFLE.**

 **WARNING: IF THE CARTRIDGE FAILS TO STRIP FROM THE MAGAZINE OR FULLY SEAT INTO THE CHAMBER, IMMEDIATELY STOP THE LOADING PROCESS. REMOVE THE MAGAZINE, LOCK THE ACTION OPEN AND VERIFY THAT THE CHAMBER IS EMPTY. REFER TO THE “INSPECTING YOUR FIREARM” SECTION OF THIS MANUAL.**

 **WARNING: ALWAYS LOAD A ROUND INTO THE CHAMBER BY FEEDING IT FROM THE MAGAZINE. NEVER ATTEMPT TO LOAD THE FIREARM BY INSERTING A ROUND INTO THE OPEN EJECTION PORT. FAILURE TO FOLLOW THIS WARNING CAN RESULT IN SEVERE INJURY OR DEATH TO YOU OR OTHERS.**

FIRING

 **WARNING: ALWAYS KEEP THE MUZZLE POINTED IN A SAFE DIRECTION.**

 **WARNING: WEAR EYE AND HEARING PROTECTION SPECIFIED FOR FIREARM USE EVERY TIME YOU DISCHARGE YOUR FIREARM. MAKE SURE OTHERS IN THE VICINITY OF WHERE YOU WILL BE SHOOTING DO SO AS WELL.**

- Grasp firearm with one hand on forend and other hand on firearm pistol grip with index finger resting along and outside of trigger guard. Raise firearm and pull buttstock against your shoulder (FIGURE 21).

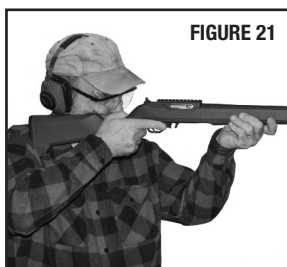

FIGURE 21

- Move safety button to the FIRE position.
- Keeping steady aim, place finger on trigger and pull gently until the rifle fires. Your firearm reloads a round into the chamber immediately after firing.
- You may continue to fire by pulling and fully releasing the trigger (between shots) until the magazine is empty.
- If you wish to stop firing before the magazine is empty, release trigger, remove finger from inside trigger guard and set safety button to the SAFE position.

FIRING CONTINUED

- If you have not fired all the rounds that were loaded into the magazine, the bolt will be closed and there will be a live round in the chamber. Keep the rifle pointed in a safe direction. Release the trigger, remove your finger from inside trigger guard and set safety button to the SAFE position.
- If you have fired the last round from the factory-supplied magazine, the bolt will be held to the rear so the chamber can be inspected to ensure that it is empty. Set the safety button to the SAFE position.

NOTE: The bolt hold-open after the last shot only works when a factory original equipment magazine is used. Aftermarket magazines will not function in the same manner and the bolt will close after the last shot has been fired from the magazine.



WARNING: THIS T/CR22™ RIFLE WILL FIRE WITH THE MAGAZINE REMOVED. KEEP YOUR FINGER OFF THE TRIGGER AND OUTSIDE THE TRIGGER GUARD UNTIL YOU HAVE MADE THE COMMITMENT TO FIRE.

CLEARING MISFIRES / MISFEEDS



WARNING: ALWAYS POINT THE MUZZLE IN A SAFE DIRECTION.



WARNING: WEAR EYE AND HEARING PROTECTION SPECIFIED FOR USE WITH FIREARMS WHEN FIRING AND CLEARING MISFIRES OR MISFEEDS.



WARNING: IF YOUR FIREARM GIVES ANY INDICATION THAT IT IS NOT PERFORMING PROPERLY OR THE OPERATION OF YOUR FIREARM HAS CHANGED “THE WAY IT FEELS OR SOUNDS”, STOP FIRING. MAKE SURE THE FIREARM IS POINTED IN A SAFE DIRECTION, UNLOAD THE FIREARM AND HAVE IT INSPECTED AND TEST FIRED BY A GUNSMITH QUALIFIED TO PERFORM SERVICE ON THOMPSON/CENTER FIREARMS

- If a cartridge fails to fire, keep the muzzle pointed in a safe direction and wait 10 seconds before opening the action and removing the suspect cartridge.
- Remove the defective cartridge and dispose of it in a method specifically approved for live round disposal.

CLEARING MISFIRES CONTINUED

- Press magazine release and remove magazine (FIGURE 22).
- Pull the bolt handle all the way back and press the bolt hold-open up and back (then allowing the bolt to move slightly forward) to hold the bolt open (FIGURE 23).
- Put the safety button into the SAFE position (FIGURE 24).
- Check chamber to be sure no cartridges are visible (FIGURE 25).
- Once the misfire is cleared, proceed to load the firearm as instructed in the Loading Section.

TO CLEAR A MISFEED (“JAM”)

NOTE: Any autoloading firearm may, on occasion, fail to feed a cartridge properly from the magazine. If this should occur:

- Be certain the muzzle is pointed in a safe direction.
- Remove the magazine from the rifle.
- Pull the bolt handle back and lock the bolt open with the bolt hold-open lever before attempting to clear the jam. Drawing the bolt fully to the rear may bring the jammed cartridge along.
- Put the safety button into the SAFE position.

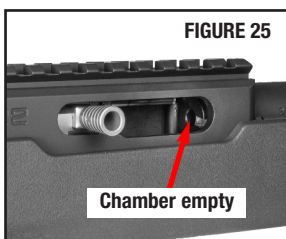
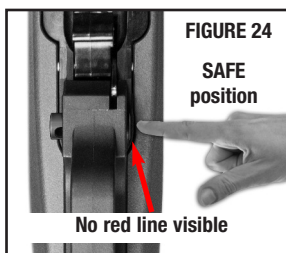
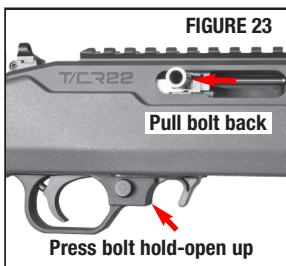
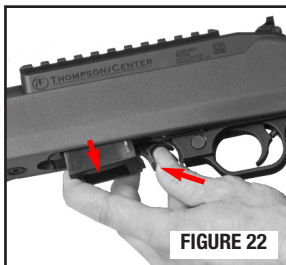

WARNING: KEEP YOUR FACE A SAFE DISTANCE FROM THE EJECTION PORT WHEN CLEARING A MIS-FED CARTRIDGE. A CARTRIDGE MAY IGNITE IF THE RIM/PRIMER OF THE CARTRIDGE IS STRUCK WITH SUFFICIENT FORCE. IF A CARTRIDGE IGNITES WHILE BEING CLEARED FROM THE FIREARM, DEATH OR SERIOUS INJURY MAY RESULT.

- It may be necessary to manually remove a jammed cartridge. When attempting to clear a jam manually, use only wood 'tools', such as a pointed dowel or a pencil, and use extreme care to avoid striking the rim/primer of the cartridge.

CLEARING MISFIRES CONTINUED

- Visually check to make sure all cartridges have been removed from the rifle. Safely dispose of any cartridges involved in a misfeed incident. Do not use damaged ammunition in any firearm.
- Once the cause for the misfeed is cleared, proceed to load the firearm as instructed in the Loading Section.

UNLOADING



WARNING: ALWAYS KEEP THE MUZZLE POINTED IN A SAFE DIRECTION.



WARNING: THIS T/CR22™ RIFLE WILL FIRE WITH THE MAGAZINE REMOVED. KEEP YOUR FINGER OFF THE TRIGGER AND OUTSIDE THE TRIGGER GUARD UNTIL YOU HAVE MADE THE COMMITMENT TO FIRE.

- Press magazine release forward and remove the magazine from the rifle (FIGURE 26).

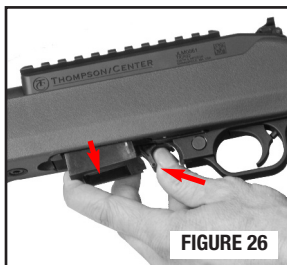

NOTE: When the last round has been fired from the magazine, the bolt will be held to the rear (open), provided that the empty magazine is in place in the rifle. The bolt hold-open after the last shot only works when a factory original equipment magazine is used. Aftermarket magazines will not function in the same manner and the bolt will close after the last shot has been fired from the magazine.

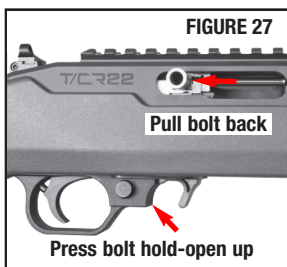

- If the bolt is not open, pull bolt handle fully to the rear and push up and back on the bolt hold-open lever (then allow the bolt to move slightly forward against the hold-open) to remove any round that was in the chamber and for inspection of the chamber (FIGURE 27).

- Push the safety button to the SAFE position (FIGURE 28).

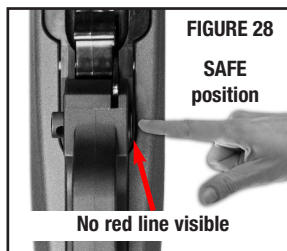

UNLOADING CONTINUED

- Look into the chamber through ejection port to ensure that the chamber is empty (FIGURE 29).
- Remove remaining live rounds from the magazine by sliding them forward and out of the magazine (FIGURE 30).
- Collect live ammunition for safe storage and the spent cartridge cases for proper disposal.

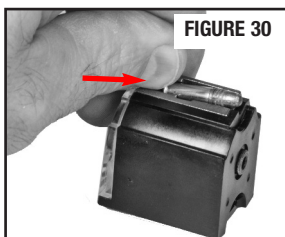
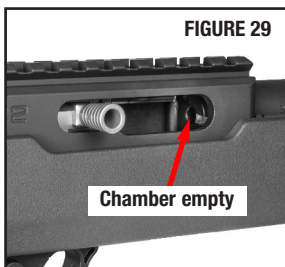

DISASSEMBLY/FIELD STRIPPING

See a video of the disassembly and reassembly of the T/CR22™ rifle on our website @www.tcarms.com/tcr22



WARNING: ALWAYS ENSURE THAT THE RIFLE IS UNLOADED BEFORE ATTEMPTING TO DISASSEMBLE OR CLEAN IT.



WARNING: ALWAYS KEEP THE MUZZLE POINTED IN A SAFE DIRECTION.



WARNING: NEVER DO ANYTHING BEYOND WHAT YOU ARE SPECIFICALLY INSTRUCTED TO DO IN THIS MANUAL. NEVER ALTER OR MODIFY THE PARTS IN YOUR FIREARM.



WARNING: WEAR SAFETY GLASSES THAT ARE SPECIFIED FOR FIREARMS USE EVERY TIME YOU ASSEMBLE OR DISASSEMBLE YOUR FIREARM.



WARNING: ANY MAINTENANCE, ADJUSTMENT OR SERVICE NOT SPECIFIED IN THIS MANUAL MAY AFFECT THE SAFETY AND RELIABILITY OF YOUR FIREARM AND MUST BE PERFORMED BY A QUALIFIED GUNSMITH USING GENUINE THOMPSON/CENTER PARTS. IF YOU DO OTHERWISE, IMPROPER FUNCTIONING OF YOUR FIREARM MAY OCCUR AND SERIOUS INJURY OR DEATH MAY RESULT.

DISASSEMBLY / FIELD STRIPPING CONTINUED

- With the rifle pointing in a safe direction, remove the magazine, open the bolt and make certain there is no cartridge in the chamber. Then allow the bolt to move forward to the closed position.
- Use a 5/32" Allen wrench to loosen the takedown bolt fully - turning it counter-clockwise as viewed from the bottom of the rifle (don't try to fully remove the takedown bolt - it is designed to stay in the stock) (FIGURE 31).
- Position the safety button so the button is centered and the same amount shows on each side of the trigger guard (FIGURE 32). Damage to the stock may occur if the safety is not in the middle when the barreled action assembly is lifted out of the stock.
- Lift the barreled action assembly upward (at the front first) away from the forend (FIGURE 33). The trigger group pins and rear bolt stop pin may fall out - be careful not to lose them.
- Once barreled action is clear of the stock (FIGURE 34), place the safety button in the SAFE position.
- Remove the trigger group assembly by simply pushing out the two trigger group pins identified here (FIGURE 35 and 36). These pins are a slip fit and may fall out on their own when the action is tipped to the side. Take care not to lose them.

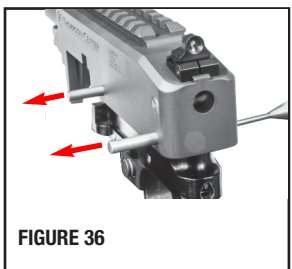
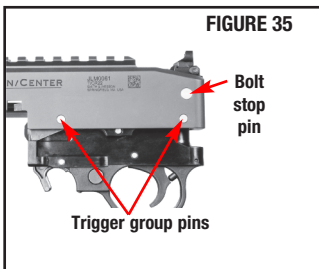
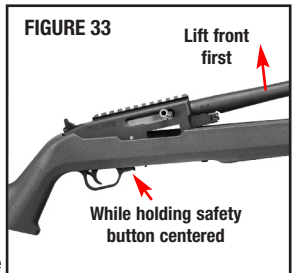
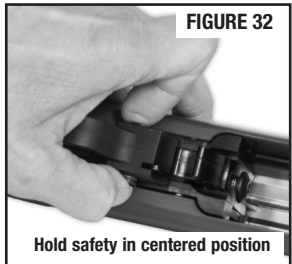
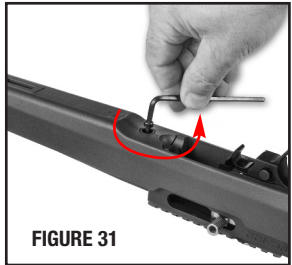

DISASSEMBLY / FIELD STRIPPING CONTINUED

- No further disassembly of the trigger group components is required (FIGURE 37).
- At this point of disassembly, normal cleaning and lubrication of the firearm can be performed.
- If you want to clean the rifle's bore from the breech end, removing the bolt and bolt handle/recoil spring assembly) is required.
- The hole at the back of the receiver allows a cleaning rod to be inserted in line with the bore (FIGURE 38).

To remove the bolt and bolt handle/recoil spring assembly from the rifle:

- Position the barreled action upside down so the bolt is fully accessible.
- Push out the bolt stop pin at the rear of the receiver (FIGURE 39).
- Pull the bolt handle fully to the rear of the receiver with one hand, and while it is held fully to the rear, lift up the front of the bolt until it is disengaged from the bolt handle and remove it from the receiver (FIGURE 40).

NOTE: If the bolt does not come out readily, turn the rifle over and the bolt will usually drop out of the receiver when the bolt handle is held fully rearward and wiggled a bit.

- Remove the bolt handle/recoil spring assembly out through the ejection port (FIGURE 41).
- Clean and lubricate the parts. See section of this manual regarding cleaning and maintenance.

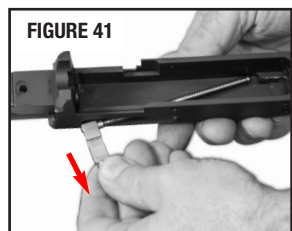
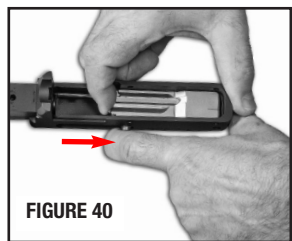
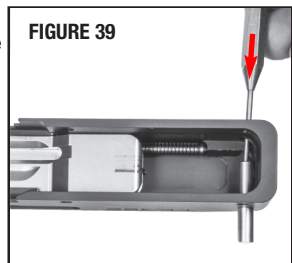
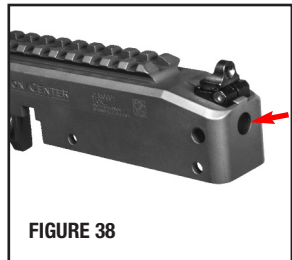

LUBRICATION

- Lubricate metal parts by wiping them with a cloth dampened slightly with a quality gun oil. Remove excess oil. Leave a light film of oil on all metal parts of your rifle - inside and out.

ASSEMBLY / FIELD STRIPPING

See a video of the disassembly and reassembly of the T/CR22™ rifle on our website @www.tcarms.com/tcr22

WARNING: ALWAYS FOLLOW THE DISASSEMBLY AND REASSEMBLY INSTRUCTIONS EXACTLY. NEVER DO ANYTHING BEYOND WHAT YOU ARE SPECIFICALLY INSTRUCTED TO DO IN THIS MANUAL. NEVER ALTER OR MODIFY THE PARTS IN YOUR FIREARM.

WARNING: WEAR SAFETY GLASSES EVERY TIME YOU ASSEMBLE OR DISASSEMBLE YOUR FIREARM.

- A padded vise or another person to hold the barreled action may make this procedure easier.

- To reassemble the bolt handle / recoil spring assembly and the bolt back into the receiver, position the recoil spring guide rod in the mating recess near the rear right side (FIGURES 42 and 43).

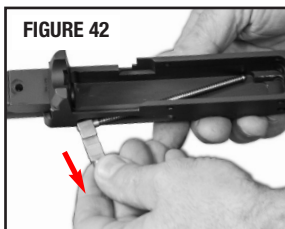

- Pull the bolt handle back fully against the rear of the ejection port (FIGURES 44 and 45), maintain it in that position with your finger and thumb. Use one hand on the bolt handle and a flat screwdriver blade on the side opposite (near the spring rod) to compress the spring fully.

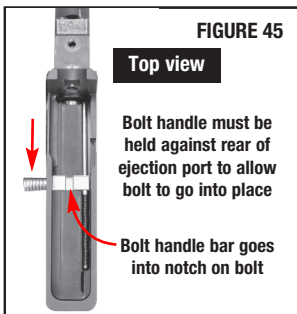
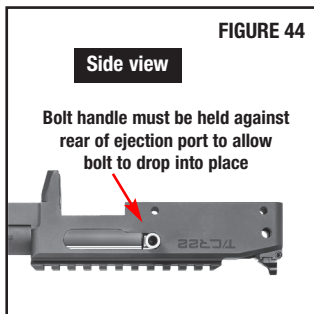
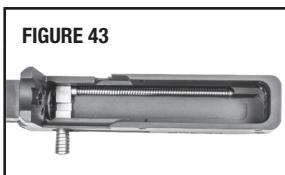

ASSEMBLY / FIELD STRIPPING CONTINUED

- Maintain the guide rod in its proper position by keeping pressure on the bolt handle with a finger on the bolt handle and your thumb against the rear of the receiver (FIGURES 46 and 47).
- Use the flat side of the screwdriver blade to compress the recoil spring bar by pressing it against the bolt handle nearest to the spring guide rod (FIGURES 46 and 47). Be careful not to scratch the finish inside of the receiver.

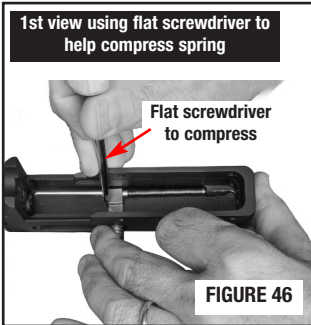

- Locate the notch (FIGURE 48) in the bolt that goes over the bolt handle bar when re-assembling.
- Lay the bolt into position with the cutout at the top of the bolt onto the section of the bolt handle that mates up with it (FIGURES 49 and 50).
- Press down on the bolt itself - until it "clicks" into place onto the bolt handle bar.
- Allow the bolt handle (with bolt now attached) to move forward slowly to the closed position.
- Cycle the bolt back and forth a few times to be certain the components are assembled correctly.

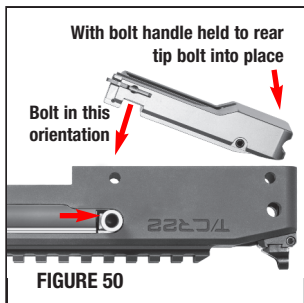
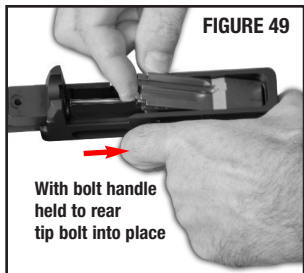
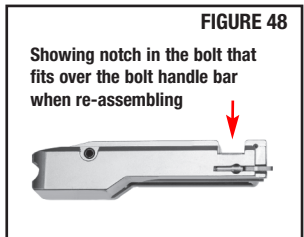

ASSEMBLY / FIELD STRIPPING CONTINUED

- Install the bolt stop pin (FIGURES 51 and 52) at the rear of the receiver into position.
- Place the trigger group into position in the receiver and install the two trigger group pins FIGURE 51 and 52). Some jiggling of the trigger group housing may be required to align the holes.

NOTE: These trigger group pins and the bolt stop pin are a slip fit and may fall out on their own when the action is tipped to the side. Take care to keep them in place while assembling the barreled action back into the stock.

- Assemble the barreled action into the stock by pushing it down and back into the opening at a slight angle (FIGURE 53).
- Once the action is seated against the rear of the opening in the stock, apply thumb pressure to the receiver near the peep sight and tip the barrel down into the forend. Be careful not to get pinched as the parts come together (FIGURE 53).
- Tighten the takedown screw until snug - (20 inch/lbs) (FIGURE 54).
- Cycle the bolt handle and check for proper function.
- Re-insert the empty magazine into the rifle and verify that the bolt stays open when the bolt handle is drawn to the rear (on an empty magazine).

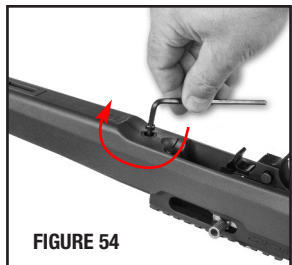
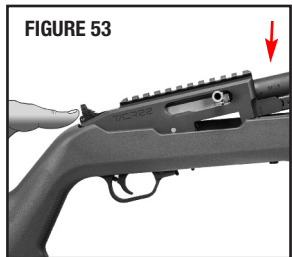
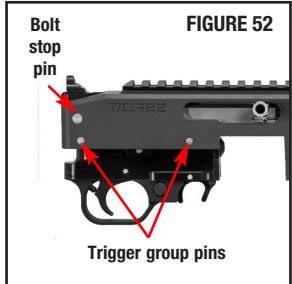
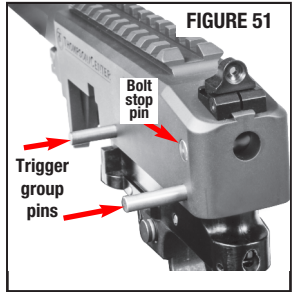

REAR SIGHT ADJUSTMENT



WARNING: ALWAYS ENSURE THAT THE RIFLE IS UNLOADED BEFORE ATTEMPTING TO ADJUST THE SIGHTS.

- The rear sight (FIGURE 55) is adjustable for windage and elevation.
- Loosen the windage lock screw with a 1/16" Allen wrench and move the rear sight blade to the right to change the bullet impact on target to the right. Move sight to the left to move bullet impact on target to the left.
- Loosen the elevation lock screw with a 5/64" Allen wrench and move the sight down the ramp to (to the rear) to lower the impact of the bullet on target - and up the ramp to raise the bullet impact on target.
- Retighten the lock screw(s) after adjustments have been made.

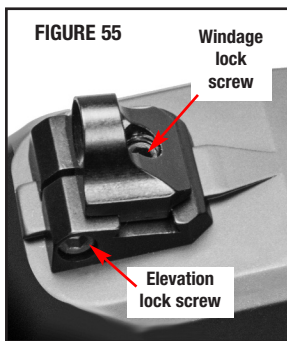

MAGAZINE



WARNING: WEAR SAFETY GLASSES EVERY TIME YOU ASSEMBLE OR DISASSEMBLE YOUR MAGAZINE. THE SPRING IN THE MAGAZINE IS UNDER TENSION. CONTROL THE SPRING AND OTHER PARTS DURING DISASSEMBLY SO THEY DO NOT FLY OUT AND CAUSE INJURY.

- The magazine can usually be “cleaned” by using (gentle) pressurized air to remove debris from within it (without disassembly). If poor function dictates, disassembly and thorough cleaning of the magazine may be necessary. Use the following procedure to disassemble and reassemble your magazine. Read through the entire process before starting.
- Ensure that the magazine is unloaded. FIGURE 56 (on the following page) shows the parts of the disassembled magazine in their proper orientation.

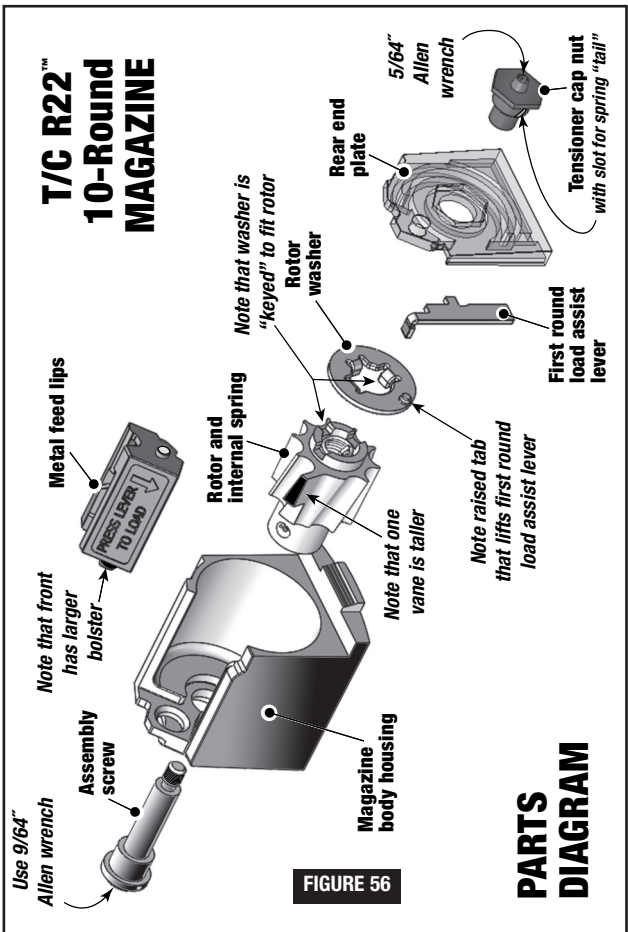

MAGAZINE CONTINUED

- Using a 9/64" Allen wrench on the assembly screw end and a 5/64" Allen wrench on the tensioner cap end, loosen the assembly screw counter-clockwise. Don't completely remove the screw yet. While loosening the assembly screw, keep slight pressure inward on the screw head and on the tensioner cap at the opposite end of the magazine. Hold pressure on the end plate and tensioner cap nut to control the parts as the screw is loosened.
- Remove the hexagon shaped tensioner cap nut and the end plate, the first round load assist lever and rotor washer will come out.
- Remove the assembly screw from the front of the magazine body.
- Remove the rotor with spring inside (There is no need to remove the spring from inside the rotor).
- Note that one vane on the rotor is longer than the others - this will be lined up at the opening of the feed lips when re-assembling.
- The metal feed lips will separate from the magazine housing. Note that the front bolster (metal protrusion) that goes in the hole at the front of the magazine body is larger than the rear one.
- Magazine is disassembled for cleaning. Gently remove any fouling from the parts of the magazine. After cleaning, wipe all parts dry prior to re-assembly. An oily or greasy magazine collects dust and debris faster than a dry one will.

See a video of the disassembly and reassembly of the T/CR22™ magazine on our website @www.tcarms.com/tcr22.

MAGAZINE CONTINUED

T/CR22™ Magazine Reassembly - (Reference FIGURE 57)

- Insert the assembly screw (#2) into the body (#1) and hold the pieces together.
- Replace metal feed lips (#3) onto magazine housing (#1). The round metal bolster at the front of the metal feed lips goes into the corresponding hole in the black plastic at the front of the magazine body.
- Insert the rotor and spring (#4) into the magazine body - in the direction shown. Orient the rotor until the longest vane is aligned between the opening of the feed lips (#3).
- Look closely at the tensioner cap nut #8. The slot in the front shaft of this part accepts the end of the spring that is inside the rotor (see FIGURES 58a and 58b).
- Lay the first round load assist lever (#6) on the magazine body and place the rotor washer (#5) in position.

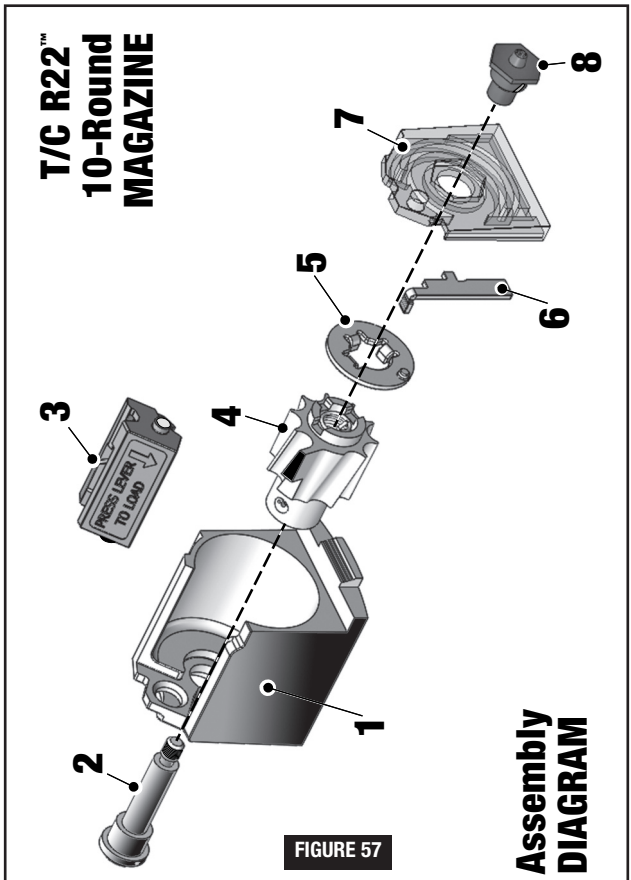

MAGAZINE CONTINUED

- Set the magazine end cap (#7) in place on the magazine housing.
- The spring “tail” (shown in FIGURES 58a and 58b) protrudes from the hole in the center of the end cap.

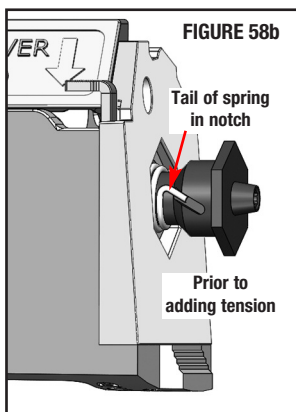
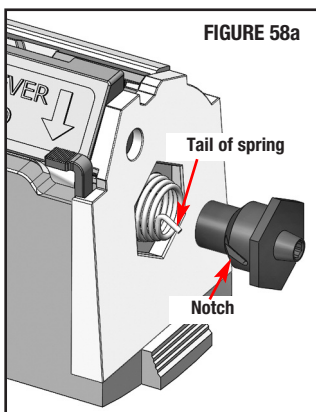

- Align the small notch on the tensioner cap nut and the spring “tail” (FIGURE 58a). Hold the tensioner nut with a 5/64” Allen wrench.
- Note that the hexagonal tensioner cap nut has six flats that are used to keep it from spinning once tensioned (FIGURE 58b).
- While holding the magazine pieces aligned and in position with the (2) Allen wrenches (FIGURE 59) - starting with the internal coil spring un-tensioned, rotate the tensioner cap 3 revolutions clockwise (as viewed from the rear - clear plastic end).

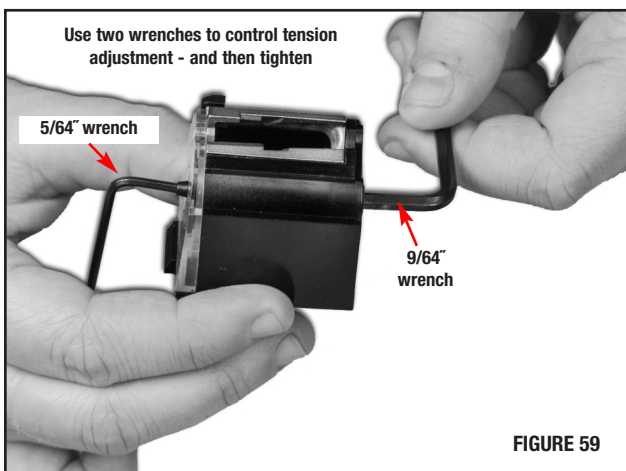

MAGAZINE CONTINUED

- Once tensioned (rotated 3 revolutions), press the tensioner nut into the corresponding recess of the (clear plastic) magazine end plate (FIGURE 60) and hold it there.

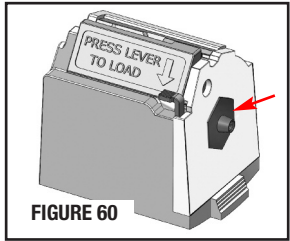

- While holding the tensioner cap nut in place, use your 9/64" hex wrench at the front of the magazine body (black plastic end) to tighten the assembly screw. Ensure that the assembly screw is tightened firmly, the screw will bottom out in the cap nut.
- With magazine reassembled (FIGURE 61), verify proper spring tension and functioning by loading and unloading several rounds. Ensure that each round springs smartly into position. Some magazines may require slight additional tensioning. If so, partially disassemble the assembly screw and adjust the tensioner cap nut, reassemble and test as detailed above.

FIGURE 61

**Rear view of
magazine**

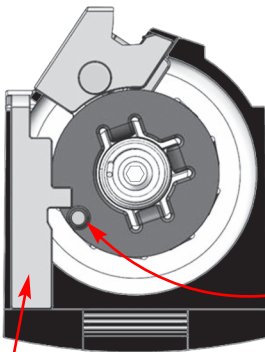

**Correct location
of the raised
portion on
the metal rotor
washer
when
re-assembling**

See a video of the disassembly and reassembly of the T/CR22™ magazine on our website @www.tcarms.com/tcr22.

SCOPE MOUNTING



WARNING: ALWAYS ENSURE THAT THE FIREARM IS UNLOADED BEFORE INSTALLING A SCOPE OR ANY OTHER ACCESSORIES. FAILURE TO DO THIS CAN CAUSE PERSONAL INJURY OR DEATH TO YOU OR OTHERS.



WARNING: A SCOPE WHICH IS NOT SECURELY MOUNTED MAY BECOME DETACHED UPON RECOIL OF THE FIREARM. IF IT BECOMES DETACHED IT MAY FLY BACK AND STRIKE THE SHOOTER OR A BYSTANDER AND CAUSE INJURY. OBSERVE THE CONDITION OF ALL THE SCOPE MOUNTING SCREWS AFTER FIRING. IF THE SCREWS SHOW SIGNS OF LOOSENING DO NOT FIRE THE FIREARM AGAIN; TAKE IT TO A QUALIFIED GUNSMITH FOR ASSISTANCE.



WARNING: FIRING A SCOPED FIREARM WITH YOUR EYE TOO CLOSE TO THE SCOPE EYE PIECE AND/OR FAILING TO HOLD THE FIREARM SECURELY AGAINST RECOIL OR FAILING TO WEAR EYE PROTECTION THAT IS SPECIFIED FOR USE WITH FIREARMS MAY RESULT IN SERIOUS PERSONAL INJURY INCLUDING, BUT NOT LIMITED TO, BLINDNESS.

- We recommend that you have a competent gunsmith install your scope on the rifle.
- The T/CR22™ has a built-in scope mount base on the top of the receiver that accepts Weaver-style or picatinny dimension rings. Different scopes have varying lengths of recommended eye relief. You need to choose a combination that allows for adequate clearance between the scope and your eye. Follow the instructions supplied with the scope and rings for proper installation.

CLEANING AND MAINTENANCE



WARNING: ENSURE THAT YOUR FIREARM IS UNLOADED BEFORE BEGINNING TO CLEAN IT. (SEE “INSPECTING YOUR FIREARM” SECTION). ALWAYS FOLLOW THE RULES OF SAFE FIREARM HANDLING.



WARNING: WEAR SAFETY GLASSES EVERY TIME YOU ASSEMBLE OR DISASSEMBLE YOUR FIREARM AND ATTEMPT CLEANING OR MAINTENANCE.

- Before using your firearm for the first time, it should be cleaned.
- Your firearm was treated at the factory with either a preservative or oil to protect it against corrosion during shipping and storage.
- Preservative and oil should be wiped from the bore, chamber and exposed areas using a clean swab or patch before using the firearm.

CAUTION: Never disassemble your firearm beyond the instructions in the Field Stripping and Inspection sections of this manual.

- Purchase cleaning supplies from your firearms dealer that are specifically designated for your type and caliber of firearm. Many suppliers offer these in kit form for your convenience.
- Follow the instructions provided with your cleaning supplies.

NOTE: A basic firearm cleaning kit should include: a brass bore brush and a cleaning jag of appropriate size for the bore being cleaned, high-quality gun cleaning solvent and gun oil/lubricant, cotton cleaning patches and a cleaning rod that is long enough to push the brush and jag completely through the barrel.

- Remove excessive firing residue from the bore and chamber using a properly fitted brass brush dipped in gun cleaning solvent. Finish the bore cleaning process by running a dry cotton cloth patch through the bore to remove residue and solvent.
- Clean the exterior of the firearm using a non-abrasive cleaning cloth.
- After cleaning, lightly coat the metal parts, internal and external with a high quality gun oil.
- Whenever your firearm has been exposed to sand, dust, extreme humidity, water or other adverse conditions, it must be cleaned and lubricated.

CLEANING AND MAINTENANCE CONTINUED



WARNING: ALWAYS HAVE ADEQUATE VENTILATION. CLEANING FIREARMS IN POORLY VENTILATED AREAS, DISCHARGING FIREARMS, OR HANDLING AMMUNITION MAY RESULT IN EXPOSURE TO LEAD AND OTHER SUBSTANCES KNOWN TO CAUSE BIRTH DEFECTS, REPRODUCTIVE HARM AND OTHER SERIOUS PHYSICAL INJURY. WASH HANDS THOROUGHLY AFTER EXPOSURE.

CAUTION: Always follow the instructions provided with your firearm cleaner and firearm lubricant.

CAUTION: Some cleaners can cause damage to your firearms. You should avoid prolonged solvent immersion and prolonged ultrasonic cleaning of your firearm. Choice of solvent should be restricted to those products specifically developed for firearms maintenance. Damage to a firearm's finish may occur if these cautions are ignored. Ammoniated solvents or other strong alkaline solvents, should not be used on any Thompson/Center firearm.

- Cleaning is essential to ensure the proper functioning of your firearm.
- Your firearm is a precision instrument. To ensure reliable function it is necessary to follow a routine maintenance procedure. After firing your firearm, be sure to unload it following the procedure outlined in the section entitled "Inspecting Your Firearm" before performing any cleaning or maintenance procedure.
- Remove any firearm cleaning solution, oil and fingerprints from the outside surfaces of the firearm. (Finger moisture, if left, could start a corrosion process).



WARNING: NEVER MANIPULATE, ADJUST OR CHANGE ANY OF THE INTERNAL COMPONENTS OF YOUR FIREARM UNLESS SPECIFICALLY DIRECTED TO DO SO IN THIS MANUAL. IMPROPER MANIPULATION OF ANY INTERNAL COMPONENT MAY AFFECT THE SAFETY AND RELIABILITY OF YOUR FIREARM AND MAY CAUSE SERIOUS INJURY OR DEATH.



WARNING: ANY MAINTENANCE, ADJUSTMENT OR SERVICE NOT SPECIFIED IN THIS MANUAL MAY AFFECT THE SAFETY AND RELIABILITY OF YOUR FIREARM AND MUST BE PERFORMED BY A QUALIFIED GUNSMITH USING GENUINE THOMPSON/CENTER PARTS. IF YOU DO OTHERWISE, IMPROPER FUNCTIONING OF YOUR FIREARM MAY OCCUR AND SERIOUS INJURY OR DEATH MAY RESULT.

- If your firearm will be used in a cold climate, be sure to use an oil of an appropriate weight so that it will not congeal in cold temperatures, causing the interaction of important parts to be slowed or halted.

CLEANING AND MAINTENANCE CONTINUED

MAINTENANCE BEFORE STORAGE

- When storing, do not encase your firearm in anything that will attract or hold moisture, for example, leather or heavy cloth. Also, do not store firearms with a plug inserted in the barrel for this can be a contributing factor to moisture accumulation. If your firearm is to be stored for an extended period, the bore, chamber and internal surfaces should be oiled with a high-quality lubricating oil or preservative intended for firearms.
- The external parts; receiver, bolt and barrel should be coated with an anti-rust oil. Before using your firearm again, be sure to clean it. Every time you clean your firearm, check it for signs of wear. If wear is noted, do not use the firearm. Return it to Thompson/Center for service or have it checked by a qualified gunsmith.

LIMITED LIFETIME WARRANTY

This warranty is granted by Smith & Wesson Corp. doing business as Thompson/Center Arms. This warranty is effective from the date of purchase for the lifetime of the original retail purchaser of any factory finished firearm. In order to be eligible for service under this warranty, the original retail purchaser must return a completed authorized warranty card or register online at <http://www.tcarms.com/warranty-details/registration> within thirty (30) days of purchase of such firearm. With respect to such firearm, this warranty supersedes any and all other warranties.

Thompson/Center Arms brand firearms are warranted to be free from defects in material and workmanship. Any such defects of which Thompson/Center receives written notice by the original retail purchaser will be remedied without charge within a reasonable time after such notification and delivery of the firearm as provided below.

To submit a warranty claim please see the "Contact and Shipping Information" below for details. In addition to the requested information, please include a copy of the bill of sale in the owner's name, or a copy of the ATF Form 4473 indicating date of purchase. It is always important that the owner comply with all applicable federal, state and local laws and regulations.

NOTE: See the Contact and Shipping section of this manual for further details regarding returns.

Warranty claims should state the model and, where applicable, the serial number of the firearm concerned and the description of the difficulty experienced. It is recommended that shipments be insured by the owner, since Thompson/Center will accept no responsibility for loss or damage in transit. Transportation and insurance charges for return to the owner will be paid by Thompson/Center if the claim is covered by this warranty.

If the work required is not covered by our "Limited Lifetime Warranty" you will receive a quotation which must be authorized by you. No actual work will be done without your approval. Return shipments can be shipped via UPS, FedEx or mail at your cost. Repaired product will be shipped back to you via FedEx requiring an adult signature upon receipt.

UNDER NO CIRCUMSTANCES SHALL THOMPSON/CENTER BE RESPONSIBLE FOR INCIDENTAL OR CONSEQUENTIAL DAMAGES WITH RESPECT TO ECONOMIC LOSS, INJURY, DEATH OR PROPERTY DAMAGE, WHETHER AS A RESULT OF BREACH OF THIS WARRANTY, NEGLIGENCE OR OTHERWISE.

Some states do not allow the exclusion or limitation of incidental or consequential damages, so the above limitation or exclusion may not apply to you.

LIMITED LIFETIME WARRANTY CONTINUED

Thompson/Center will not be responsible for:

- Defects or malfunctions resulting from careless handling, unauthorized adjustments or modifications made or attempted by anyone other than a qualified gunsmith following authorized procedures, or failure to follow the instructions in Safety and Instruction manual that was provided with the firearm from the factory.
- Use of defective or improper ammunition and/or propellant, corrosion, neglect, abuse, ordinary wear and tear, or unreasonable use.
- Use of replacement parts, including but not limited to barrels and springs, other than factory or authorized parts.
- Criminal misuse, negligence, or use under the influence of drugs or alcohol.

Services that were performed by the Thompson/Center Arms Custom Shop and/or that are performed by the Thompson/Center Repair Department do not void this warranty. This warranty gives you specific legal rights, and you may also have other rights which vary from state to state.

NOTE: All liability is excluded in the event that the instructions provided in the Safety and Instruction manual that was provided with the firearm from the factory are not observed.

CONTACT AND SHIPPING INFORMATION

NOTE: A Return Merchandise Authorization (**RMA**) is the first step in the process of returning a product in order to receive a repair, replacement or refund.

Please contact Thompson/Center's Customer Service Dept. (e-mail: tca_customerservice@tcarms.com or by phone at 1-866-730-1614 to obtain authorization to return your firearm so we can process it quickly and efficiently. The RMA number that is supplied by Thompson/Center Arms must be displayed on the outside of the returned product's packaging; returns without an RMA number will be routed differently which will result in delayed processing.

The Return Merchandise Authorization (**RMA**) procedure allows Thompson/Center Arms an opportunity to try to diagnose and correct a customer's concerns with the product (such as ammunition problems) before it is returned. Accordingly, please contact us before returning your Thompson/Center firearm.

Shipping Address:

Thompson/Center Arms
2100 Roosevelt Avenue
Springfield, MA 01104

Should your Thompson/Center firearm require service, it should be returned to the Thompson/Center factory.

- Call or e-mail the Customer Service Dept. for authorization and shipping instructions.
- **Ensure that the magazine and chamber are unloaded.**
- **Do not attempt to ship a firearm via US Postal Service; only federally licensed dealers may ship a firearm by US Postal Service.**
- **DO NOT SHIP ANY AMMUNITION.**
- Enclose a letter which includes your full name and physical address (no P.O. Boxes, please), daytime telephone number, e-mail address, the serial number of the firearm, and details of the problem experienced (stating the brand and type of ammunition used when the problem occurred) or work desired.
- Record the serial number before shipping, in case you wish to check on the repair status of your firearm.
- Please remove all custom parts and accessories, such as stocks, special sights and scopes, or slings from your firearm before returning.

CONTACT AND SHIPPING CONTINUED

- Place the firearm in its original case or in a similarly secure container and pack it securely.
- The package must NOT bear any markings which indicate the identity of the contents.
- It is most important that you comply with federal, state, and local laws and regulations. The following guidelines are meant to help, but you must seek assistance from the appropriate authorities if necessary.
- If your firearm must be replaced, it may be necessary to ship the replacement to a dealer rather than directly to you. You may be requested to furnish a signed FFL (Federal Firearms License) from your dealer in such an instance.
- Warranty repair work will begin upon receipt and examination of the firearm. In the case of repairs or work not covered by the warranty, a quotation covering the cost of the work plus shipping charges will be sent to you. Repairs or modification will be scheduled upon receipt of payment.



WARNING: YOU MAY PURCHASE ACCESSORIES FOR YOUR THOMPSON/CENTER FIREARM. YOU MUST HAVE SOME OF THESE PARTS INSTALLED BY A GUNSMITH QUALIFIED TO PERFORM SERVICE ON THOMPSON/CENTER FIREARMS. NEVER ATTEMPT TO MODIFY YOUR FIREARM OR INSTALL REPLACEMENT PARTS IN YOUR FIREARM. ALWAYS USE A QUALIFIED THOMPSON/CENTER GUNSMITH EVEN IF THE REPAIR SEEMS SIMPLE.

M-LOK® ACCESSORY SLOTS

WARNING: ALWAYS ENSURE THAT THE FIREARM IS UNLOADED BEFORE INSPECTING, DISASSEMBLING OR ASSEMBLING (INCLUDING ACCESSORIES) AND ALWAYS KEEP THE MUZZLE POINTED IN A SAFE DIRECTION.

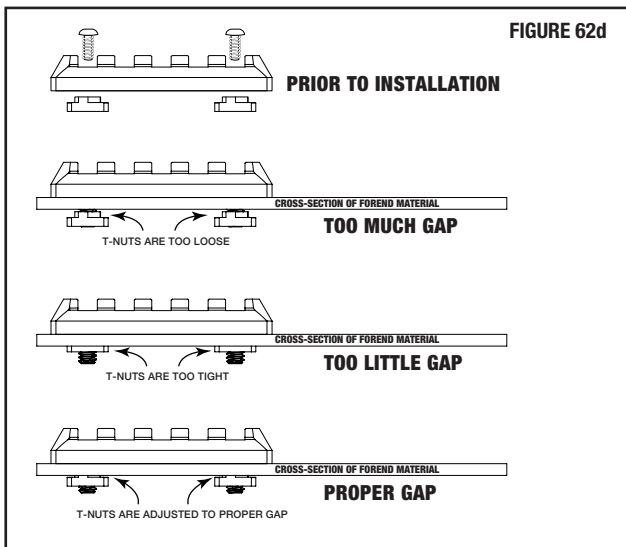
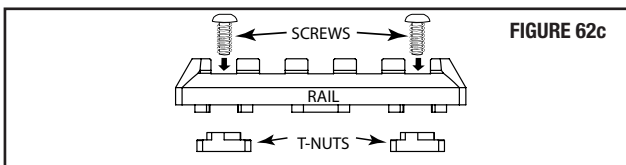
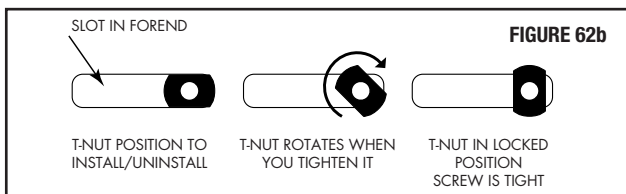
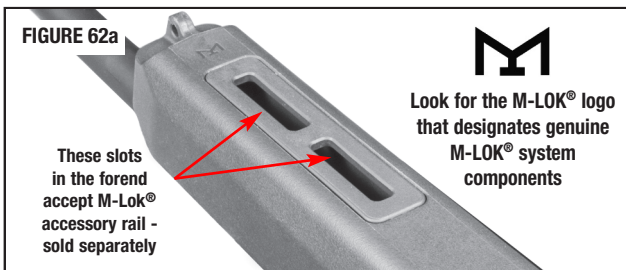

• M-Lok® is a registered trademark of MagPul Industries, Corp.

BATTERY WARNINGS



WARNING: IF A BATTERY OPERATED ACCESSORY OR ATTACHMENT (I.E. LASER, OPTICAL SIGHT OR FLASHLIGHT, ETC.) IS SUPPLIED OR USED WITH THIS FIREARM, THE FOLLOWING WARNINGS AND INSTRUCTIONS MUST BE ADHERED TO.



WARNING: KEEP BATTERIES AWAY FROM CHILDREN. THERE IS A CHEMICAL BURN HAZARD ASSOCIATED WITH BATTERIES.



WARNING: IF A NEW OR USED LITHIUM BUTTON/COIN CELL BATTERY IS SWALLOWED OR ENTERS THE BODY, IT CAN CAUSE SEVERE INTERNAL BURNS AND CAN LEAD TO DEATH IN AS LITTLE AS 2 HOURS. ALWAYS COMPLETELY SECURE THE BATTERY COMPARTMENT. IF THE BATTERY COMPARTMENT DOES NOT CLOSE SECURELY, STOP USING THE PRODUCT, REMOVE THE BATTERIES, AND KEEP IT AWAY FROM CHILDREN. IF YOU THINK BATTERIES MIGHT HAVE BEEN SWALLOWED OR PLACED INSIDE ANY PART OF THE BODY, SEEK IMMEDIATE MEDICAL ATTENTION.

- When used correctly, batteries provide a safe and dependable source of portable power. However, misuse or abuse may result in leakage, fire, or explosion.
- Batteries can explode or leak and cause burns if installed backwards, disassembled, charged, or exposed to water, fire or high temperature.
- Always take care to install your batteries correctly observing the “+” and “-” marks on the battery and the device.
- Always replace the whole set of batteries at one time, taking care not to mix old and new batteries, or batteries of different types.
- Store unused batteries in their original packaging and away from metal objects that may short-circuit them.
- Remove discharged batteries from equipment promptly to avoid possible damage from leakage.
- Never dispose of batteries in fire. (Failure to observe this precaution may result in an explosion.)
- The batteries are supplied in a charged state, are not designed for recharging. Recharging may cause leakage, fire, or explosion.
- The batteries should be disposed of properly, including keeping them away from children.
- Dispose of used batteries immediately.
- Even unused batteries may cause injury.

PATENT INFORMATION

This product may be covered by one or more patents.
Visit www.tcarms.com for virtual patent information.

T/C Mailing Address:
(for questions and comments)

Thompson/Center Arms
2100 Roosevelt Avenue • Springfield, MA 01104

T/C Shipping Address:
(for repairs or warranty work)

Thompson/Center Arms
ATTN: Repair Department
2100 Roosevelt Avenue • Springfield, MA 01104

Web Address:

www.tcarms.com

Customer Service Phone:

Toll Free: 1-866-730-1614

Customer Service email:

tca_customerservice@tcarms.com



3008155

Thompson/Center
2100 Roosevelt Avenue • Springfield, MA 01104
www.tcarms.com